

1

2

3

4

A

A

B

B

C

C

D

D

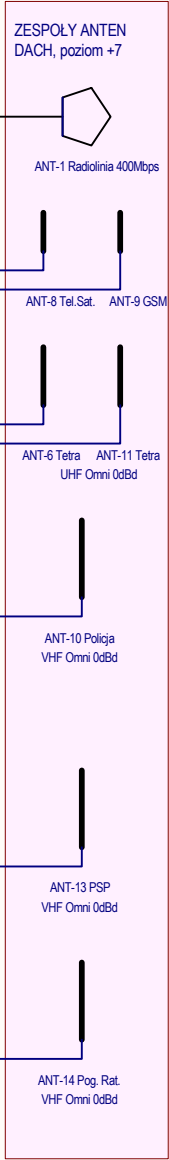
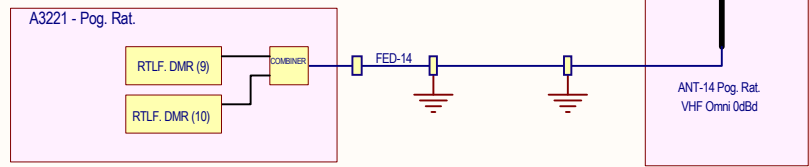
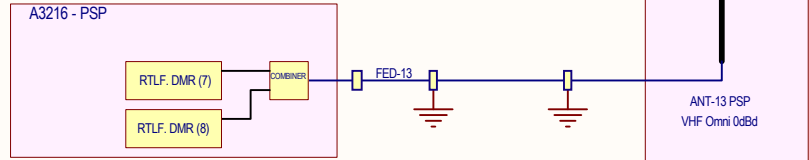
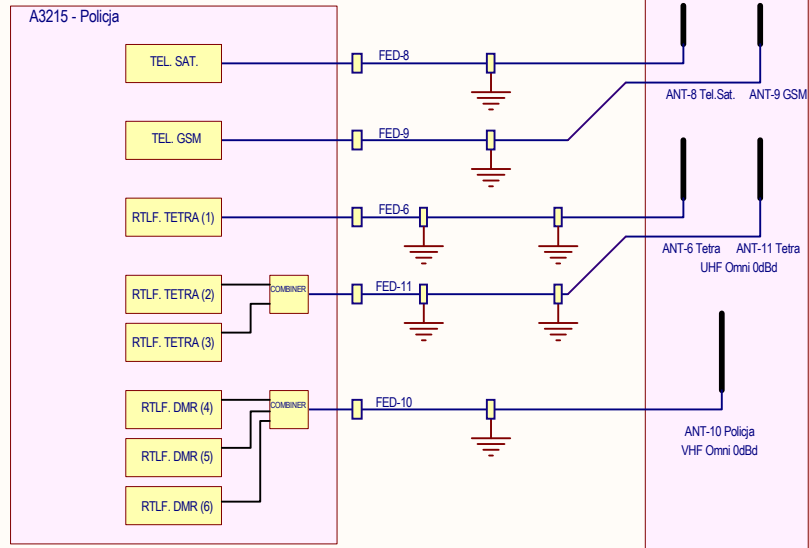
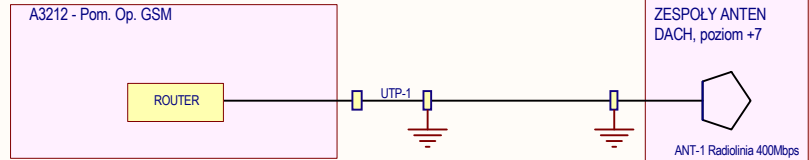
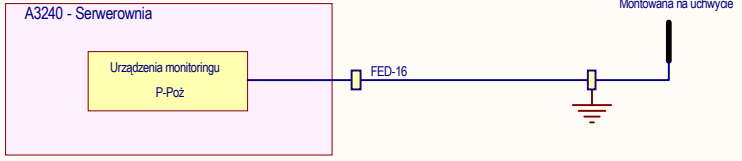
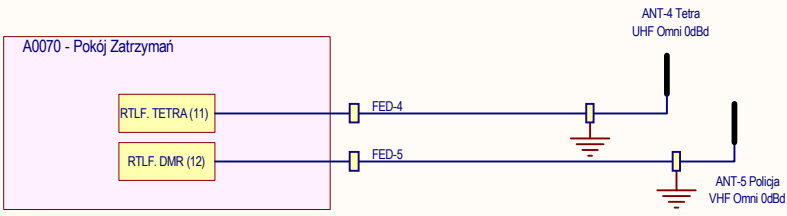

- OZNACZENIA:
- Urządzenie
 - Pomieszczenie
 - Feeder anteny 1/2"
 - Feeder anteny 7/8"
 - Jumper 5mm
 - Światłowód jednomodowy, 2-włókna
 - Skrętka UTP
 - Zasilanie gwarantowane 230V AC
 - Ochronnik anteny
 - Opaska uziemiająca

Schemat systemu łączności radiowej - Cz. 1.

Rys. 1a

1

2

3

4